

# POWERFUL AND RELIABLE AGRICULTURAL TECHNOLOGY

Pumps and cutters  
for agriculture

**VOGELSANG – LEADING IN TECHNOLOGY**

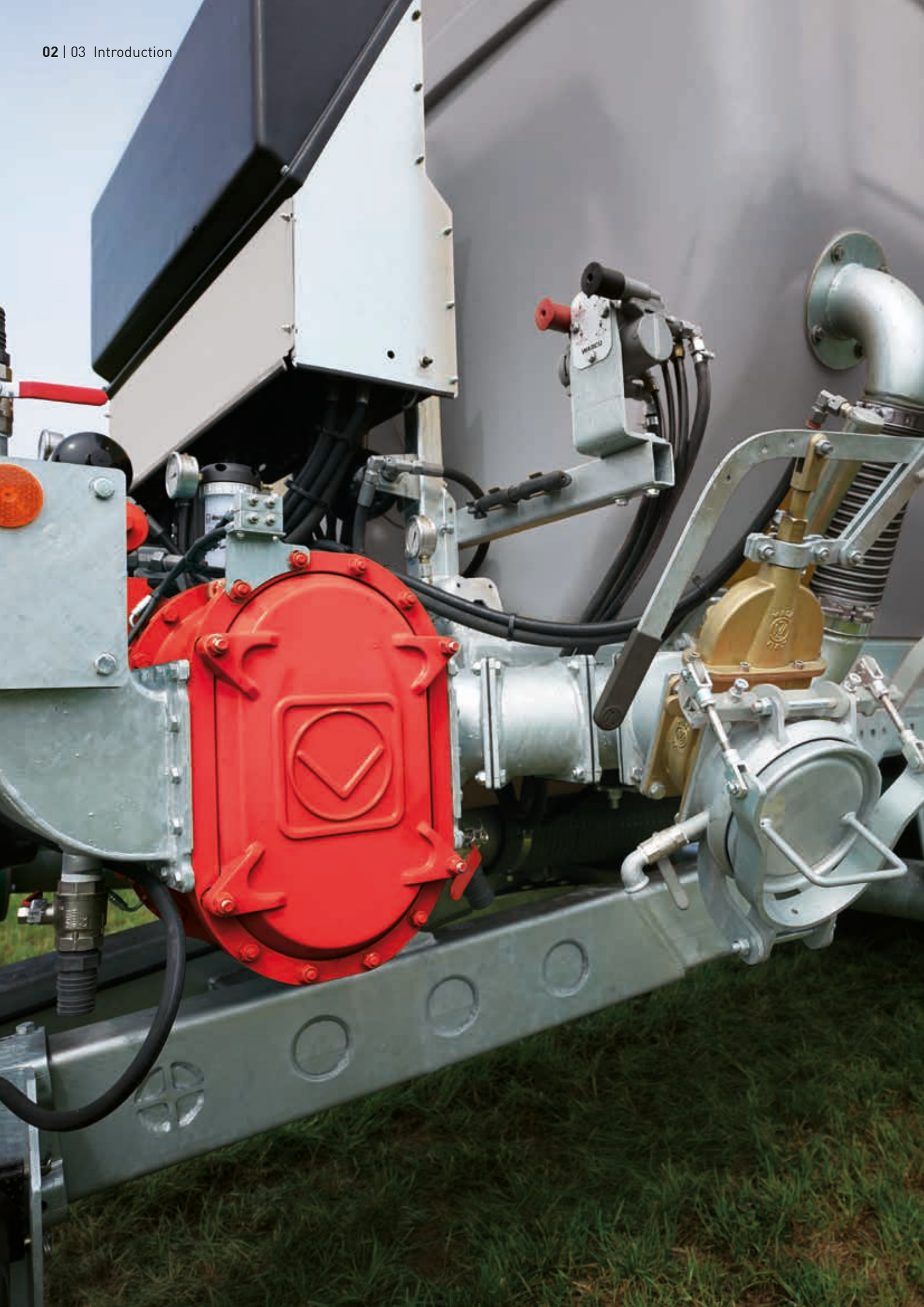



# YOU CAN RELY ON IT

**Quality, experience and  
expertise guarantee  
future-proof technology**

**As a pioneer in agricultural technology, Vogelsang remains one of the leading mechanical engineering companies in this sector. Farmers and contractors worldwide rely on the innovative design and high quality standards of our rotary lobe pumps and cutters.**

Based on our diverse experience and constant research, we develop powerful and need-based machines that also impress with their low maintenance requirements and exceptional durability.

Both the production and material quality of our rotary lobe pumps and cutters are testimony to our responsible actions for the benefit of our customers. Their adaptability and versatility foster economy as well as sustainability, and allow agricultural operations to react effectively to current circumstances and any requested changes.

# MAXIMIZE THE VALUE OF LIQUID MANURE AS A MATERIAL

**Reliable pump and shredding  
technology for nutrient-efficient,  
modern liquid manure management**

## **Liquid manure as a nutrient source**

Liquid manure and digestates are essential valuable materials in agriculture, and the basis for a good nutrient supply for soils and crops and a successful harvest. Anyone who uses these natural fertilizers correctly and precisely can significantly reduce the need for organic fertilizer. Not just any pump and shredding technology can deliver this organic fertilizer to the field effectively. The liquid manure not only contains fibrous material, it also generally contains all kinds of foreign matter. Vogelsang can support you in managing the processes involved by providing innovative and reliable technology that is backed by decades of experience.

## **Pumps for the farm**

Transferring, draining, filling – whatever the day brings, the job has to be done. With their many useful characteristics, Vogelsang rotary lobe pumps help you in your daily work. Among other features, our pumps include the InjectionSystem and Cartridge mechanical seals, which make the pumps more resistant to fibrous and foreign material.

## **Equipment for spreader vehicles**

Less foam, complete filling, large suction capacity and even draining: with the low-maintenance, compact Vogelsang rotary lobe pumps and RotaCut cutters, you can make the most of your spreader vehicle's potential.

## **Mobile solutions**

Vogelsang provides maximum pumping power for effective liquid manure spreading with field-side containers, filling stations and tankers: sophisticated solutions with powerful technology that improves your efficiency.

## **Variety of solutions**

Vogelsang pumps offer a variety of configurations: permanently installed, on a three-point base, with electric or hydraulic motor, or with PTO drive.

# Overview of Vogelsang agricultural technology

## Rotary lobe pumps

---



### R-Serie

- Sturdy pump technology for simple applications
- Performance: max. 5 bar, max. 6,000 l/min



### FX-Serie

- Developed specifically to meet the tough demands of agriculture
- Circulating oil lubrication makes it easy to operate
- Performance: max. 8 bar, max. 4,500 l/min



### VX-Serie

- Powerful top technology
- Long service life and low maintenance requirements thanks to HiFlo lobes and InjectionSystem
- Cartridge mechanical seal
- QuickService concept for fast wear part replacement
- Performance: max. 16 bar, max. 23,630 l/min

## Rotary lobe pumps

---



### GL -Serie

- Up to 54 % less weight
- Up to 35 % less space
- Easier service
- Lower power consumption
- Incredibly quiet running



### ProCap T

- High-quality mechanical seal for long life
- Hollow rotor for smooth running
- Robust, maintenance-free universal joints



### RotaCut® MXL

- Incomparable shredding technology for high reliability and economy
- Including a heavy material separator for use on a tanker increases operational safety

## Filling technology

---



### Powerfill

- Filling aid for vacuum systems
- Saves up to 30 % of time when filling the tank and homogenizes the liquid manure during filling



### FillMaster

- Effective filling stations
- Problem-free filling of liquid manure tank-vehicles no matter what the location



Vogelsang Pump VX 100

# EXPERIENCED LIQUID MANURE SPECIALISTS

**The Vogelsang rotary lobe pumps –  
The epitome of simple, reliable and  
rapid pumping for 30 years**

Vogelsang pumps are powerful, self-priming, reversible and, first and foremost, impervious to foreign matter. They are now an indispensable component of tankers. No wonder that Vogelsang rotary lobe pumps have become the epitome of liquid manure pumps in the agricultural sector in the past 30 years. After all, rugged technology is particularly necessary here and Vogelsang machines have proven their reliability again and again for transferring, pumping and filling.

## Optimal liquid manure management

Operational safety and speed are the crucial factors for optimum liquid manure management. Tanks or self-propelled vehicles equipped with rotary lobe pumps offer both to facilitate effective delivering of liquid manure and digestates.

## Integrated mixing

Active transferring/circulation homogenizes the liquid manure in the tank. This prevents a buildup of fibrous matter.

## Even distribution

The pump system spreads the liquid manure constantly and evenly, regardless of how much liquid is in the tank or how much pressure there is. Even application is paramount for using liquid manure as an organic fertilizer.

## Schematic performance calculation of rotary lobe pumps compared with vacuum and centrifugal pumps

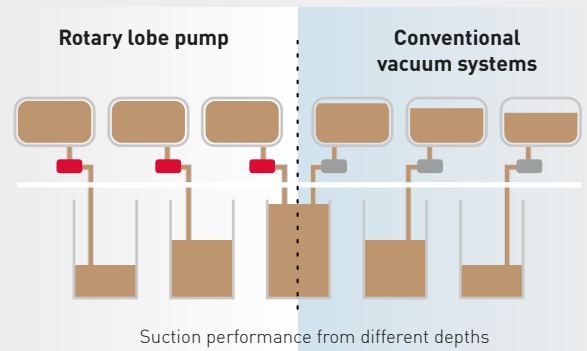
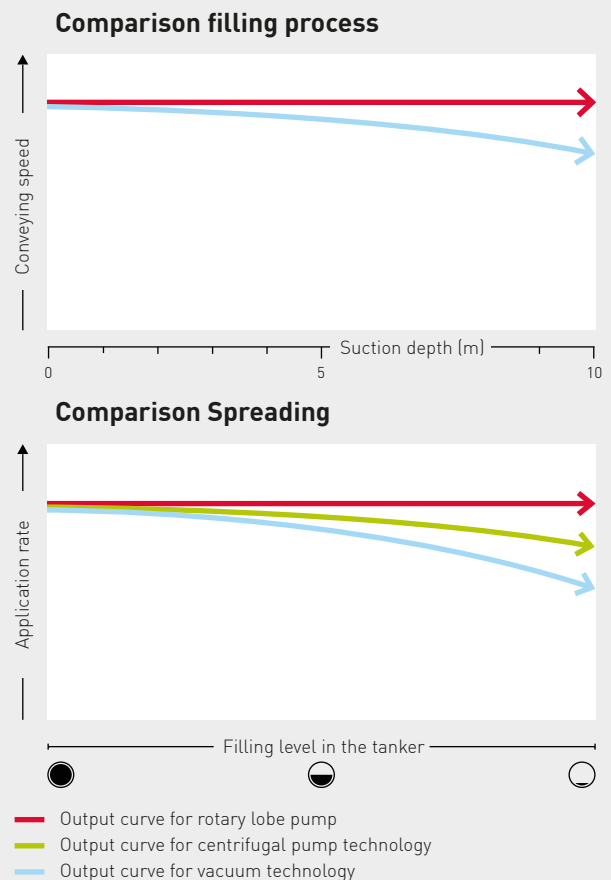

Regardless of the suction depth the tanker will be filled in a constant speed and especially completely by the rotary lobe pump.

## More volume, less foam

- In pump tanks, the vacuum remains constant and powerful throughout the entire filling process
- Minimum loss of suction power for liquid manure-pits to depths of up to eight meters
- Low foaming
- 30 % time advantage when filling, compared with vacuum tanks
- Full tank volume can be used

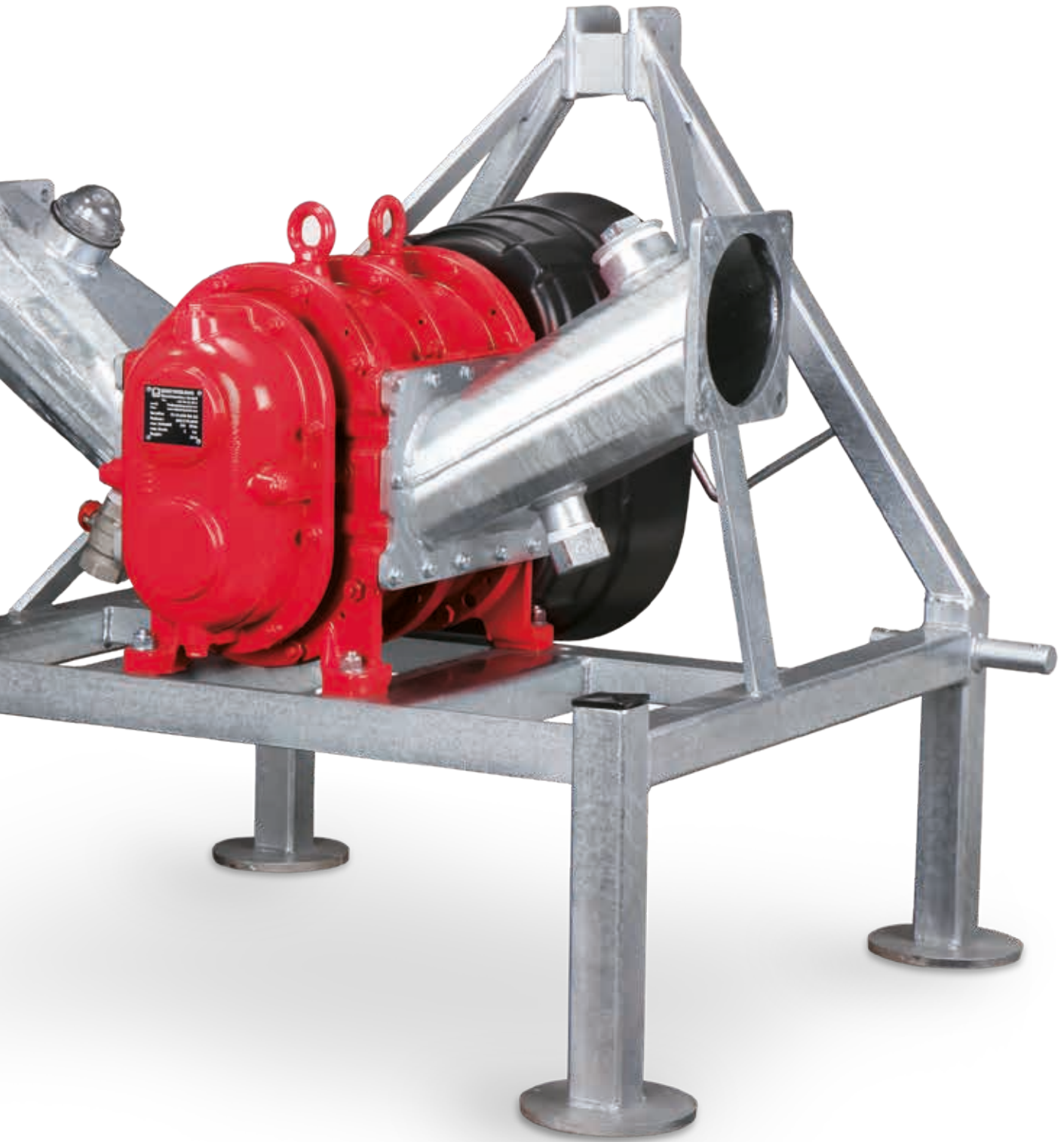

The R series



# RUGGED AND EASY TO USE

## The R series as a reliable liquid manure pump for farms and fields

### The R series at a glance

- 2 different series with up to 7 different capacity levels
- Up to 6,000 l/min
- Pressures up to 5 bar

With their simple and sturdy equipment, Vogelsang rotary lobe pumps in the R series are the endurance runners in agriculture. The rotary lobe pumps have a double bearing, a generously dimensioned shaft diameter and a basic selection of sizes, lobes and materials. The R series is particularly well suited as a liquid manure pump around the farm, as a filling and draining pump for tankers or as a mobile pump. Like all Vogelsang rotary lobe pumps, the R series is self-priming, very resistant to dry running and can be operated in both flow directions. The offset arrangement of the rotary lobes ensures running with low pulsation.



### Advantages of the R series

- Self-priming
- Resistant to foreign matter
- Straight rotary lobes
- Axial wear plates made from highly wear-resistant

**Materials in the R series**

The pump chamber for the R series is made of gray cast iron, with good anti-friction characteristics and a strong resistance to abrasive wear. The face sides, which are subjected to greater strains, are protected from wear by high-strength special steel plates.

**Lobes in the R series**

We have developed special compounds for the elastomer that surrounds the lobe core in our rotary lobe pumps. They make it possible to tailor every pump to the specific medium and guarantee extra durability. We have a range of options available for lobes in the R series, e.g., NBR or SBR.

**Drive types in the R series**

- Cardan shaft
- Hydraulic motor
- Geared motor
- Combustion motor

**SPECIFICATIONS**

Type	Stroke vol,	Max, pressure	Max, capacity*		Max, speed
	l		bar	l/min	
<b>R116 series</b>					
60	1.16	5	750	45	650
120	2.32	5	1,500	90	650
180	3.48	5	2,250	135	650
240	4.64	5	3,000	180	650
300	5.80	4	3,800	225	650
360	6.96	3	4,500	270	650
<b>R136 series</b>					
70	1.25	5	800	45	650
105	1.90	5	1,200	70	650
140	2.53	5	1,650	90	650
210	3.80	5	2,500	140	650
350	6.33	5	4,100	230	650
420	7.59	5	5,000	280	650

The R136 series is also available with the InjectionSystem on request.

\* Maximum, theoretical capacity. In practice, the capacity is normally lower, depending on pressure difference, medium viscosity and pump installation. We would be happy to configure the best rotary lobe pump for your application with the help of our computer-assisted design software.

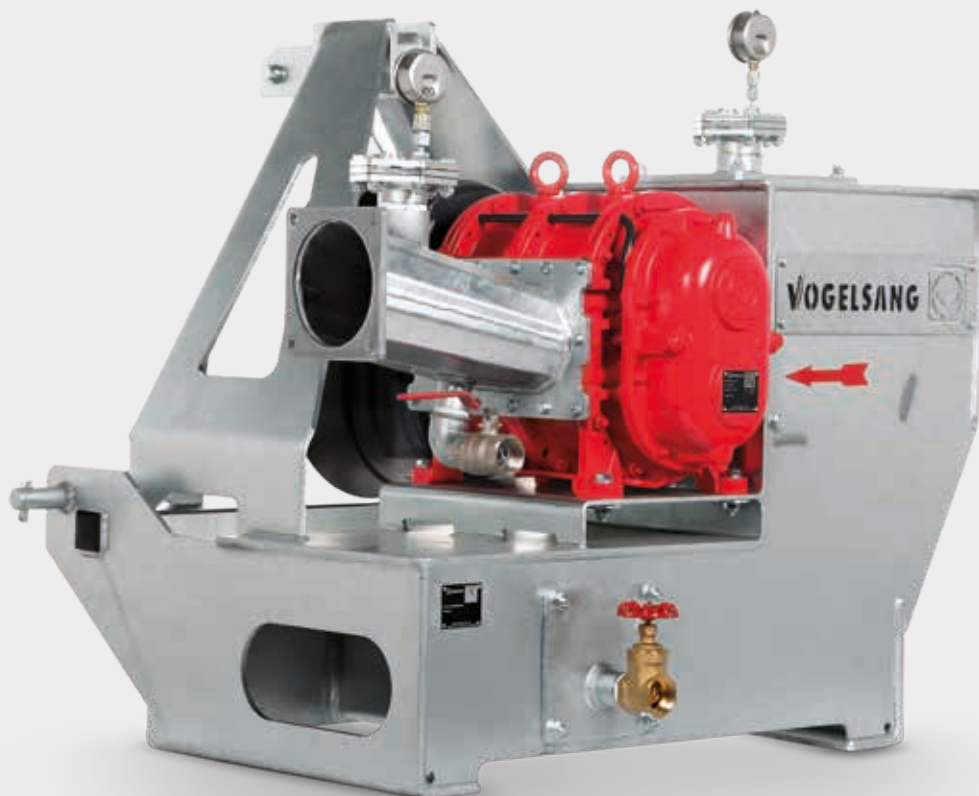

R series in combination  
with foreign matter separator



# MAKING THE BASICS BETTER

**The FX series makes everyday life easier and reduces operating costs**

## **The FX series at a glance**

- Different capacity levels
- Up to 4,500 l/min.
- Pressures up to 8 bar

The FX series by Vogelsang was developed specially for the needs of farmers. It fulfills the special requirements of liquid manure as the medium, is easy to operate and is highly economical in operation thanks to its quality and ease of maintenance. As a professional liquid manure pump without torque boost, it offers a max. performance of 8 bar and a max. 4,500 l/min.

## **Lubrication no longer necessary**

Sometimes it's the little things that make a pump part of the FX series: Vogelsang eliminates lubrication from your list of jobs. Simple and effective oil circulation lubrication means that all gaskets are constantly lubricated and the grease gun remains on the shelf.



## **Advantages of the FX series**

- Block ring seal
- Axial wear plates made from highly wear-resistant special steel
- Rotating separation plate – low energy consumption
- Circulating oil lubrication – no follow-up lubrication of the pump

### Pump liquid manure professionally without increasing torque

Liquid manure contains a lot of fibrous material that gathers in gaps and cavities and can increase the torque. This increases wear, wastes pumping power and ultimately energy. The FX series rotates the separation plate with the pistons: one less fiber trap, combined with greater pump power and lower diesel or electricity consumption.

### Block ring seals for longer pumping times and reduced service times

Mechanical seals are significantly more durable than radial shaft seals. The FX series uses Vogelsang's specially developed block ring variant of the mechanical seal. The special block increases the pump's resistance to fibers in the liquid manure even further.

### FX series rotary lobes

Depending on the medium, Vogelsang offers the FX series with different elastomer compounds as a coating for the rotary lobe cores, e.g., NBR or SBR.

### FX series drive types

- Cardan shaft
- Hydraulic motor
- Electric motor
- Combustion motor

## SPECIFICATIONS

Type	Stroke vol.	Max. pressure	Max. capacity*		Max. speed
	l	bar	l/min	m <sup>3</sup> /h	min <sup>-1</sup>
FX116-60	1.16	8	750	45	650
FX116-120	2.32	7	1,500	90	650
FX116-180	3.48	6	2,250	135	650
FX116-240	4.64	5	3,000	180	650
FX116-300	5.80	4	3,800	225	650
FX116-360	6.96	3	4,500	270	650

\* Maximum, theoretical capacity. In practice, the capacity is normally lower, depending on pressure difference, medium viscosity and pump installation. We would be happy to configure the best rotary lobe pump for your application with the help of our computer-assisted design software.



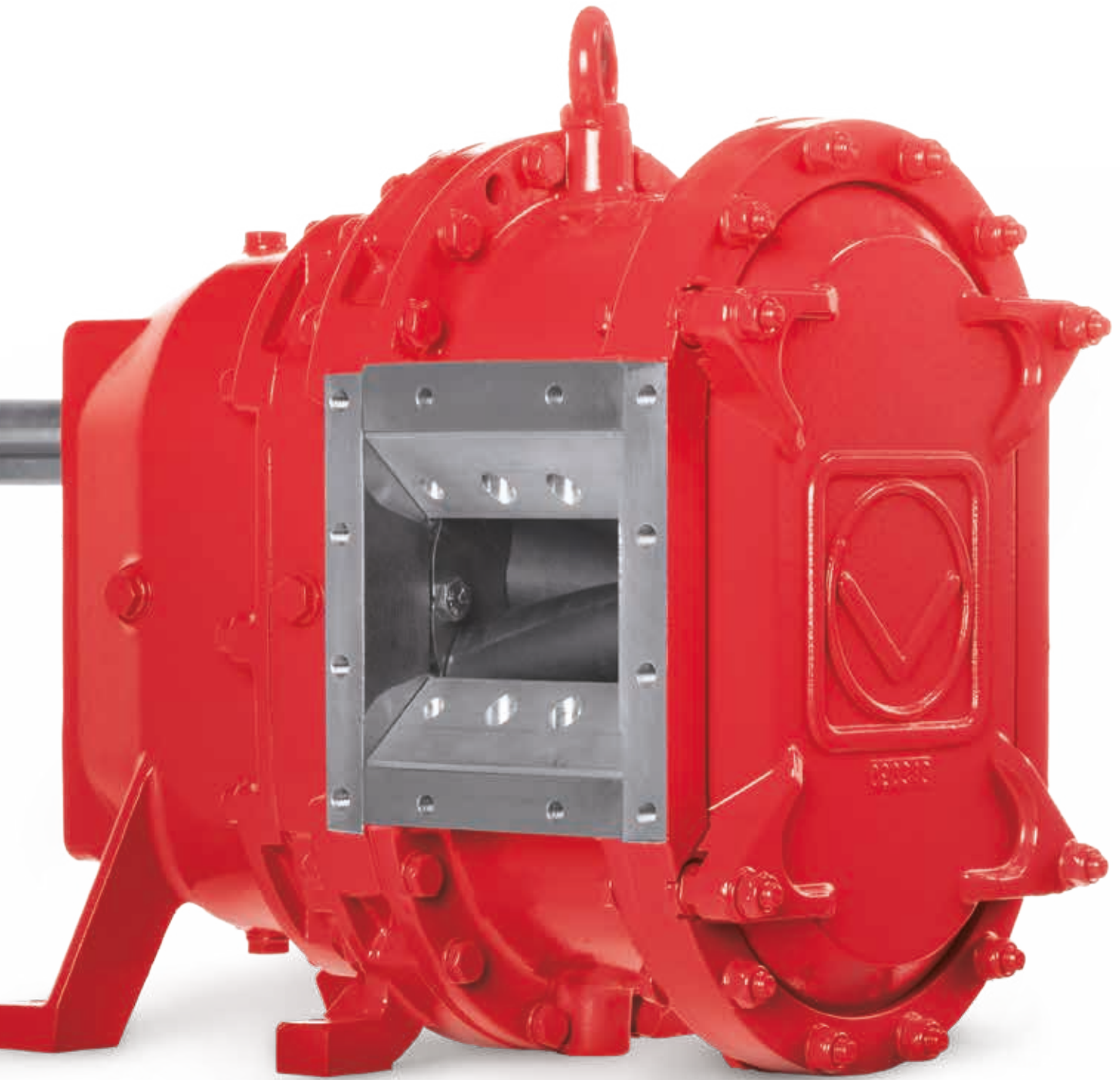

VX series



# SIMPLY MORE ECONOMICALLY BUILT

**The VX series for longer runtimes,  
quick maintenance and  
high levels of operational safety**

## **The VX series at a glance**

- 5 different series with up to 8 different capacity levels
- Up to 23,600 l/min.
- Pressures up to 16 bar

With pumping outputs of up to 16 bar and up to 23,600 l/min., VX series rotary lobe pumps provide effective support for any size of tank with maximum performance. Based on requirements, there is a large selection of models, lobe types, materials and protective coatings available for the VX series. Everything is designed to increase operational safety in the tank and to lengthen the service life. To do this, the VX series combines high-end pump technology with compact dimensions.

VX series rotary lobe pumps from Vogelsang are used in any applications requiring compact, self-priming pump technology that is resistant to dry running, which demand high ease of maintenance. A range of technical innovations provide low downtimes, minimize operating costs and The VX series ensure quick-and-easy maintenance.



## **Advantages of the VX series**

- Comprehensive range of technical details and options
- Quick access to the pump chamber by removing the cover
- Self-priming
- Resistant to foreign matter
- Pulsation-free pumping

## The types

**Q – QuickService pumps:** On one side, dual cantilever bearings; on the other, quick-and-easy access to the pump chamber. All wetted parts can be replaced without removing the pump on-site. That makes for short downtimes.

**QD – QuickService pumps with third bearings :** In the unique QD design, an additional, third support bearing provides extra stability and extremely low shaft deflection, resulting in minimum start-up wear. This increases the service life significantly and provides full QuickService functionality.

## The drive types

- Geared motor
- Cardan shaft/manual gearbox
- Hydraulic motor
- Combustion motor

## The lobes

We have developed special compounds for the elastomer that surrounds the lobe core in our rotary lobe pumps. They make it possible to tailor every pump to the specific medium and guarantee extra durability. We have a range of options available for lobes in the VX series, e.g., NBR or SBR. If the focus is on high volumetric efficiency and pulsation-free running, the patented HiFlo lobes are the ideal choice. Constant pumping and more sealing lines allow high pressures and drawing of fluid from deep pits.

## SPECIFICATIONS

Type	Stroke vol. l	Max. pressure		Max. capacity*		Max. speed min <sup>-1</sup>	Max. shaft deflection	
		Q bar	QD bar	m <sup>3</sup> /h	l/min		Q mm/bar	QD mm/bar
<b>VX136 series</b>								
70	1.27	10	12	61	1,010	800	0.01	0.002
105	1.90	10	12	91	1,520	800	0.03	0.004
140	2.53	8	12	121	2,020	800	0.05	0.007
210	3.80	5	10	182	3,040	800	0.16	0.016
280	5.06		8	243	4,040	800		0.031
420	7.59		6	364	6,070	800		0.090
<b>VX186 series</b>								
92	3.56	10		128	2,130	600	0.01	
130	5.03	10	12	181	3,010	600	0.02	0.003
184	7.12	8	12	256	4,270	600	0.05	0.008
260	10.06	5	10	362	6,030	600	0.12	0.012
368	14.24	2 (3**)	8	513	9,000	630	0.33	0.028
390	15.09	2 (3**)	7	543	9,050	600	0.40	0.028
520	20.12		6	724	12,070	600		0.065
736	28.48		3	1,025	17,080	600		0.191
<b>VX215 series</b>								
226	15.47	5	8	501	8,350	540	0.10	0.010
320	21.88	2.5	7	708	11,810	540	0.29	0.026
452	30.94		5	1,002	16,700	540		0.029
640	43.76		3	1,417	23,630	540		0.073

\* Maximum, theoretical capacity. In practice, the capacity is normally lower, depending on pressure difference, medium viscosity and pump installation. We would be happy to configure the best rotary lobe pump for your application with the help of our computer-assisted design software. \*\* Not for permanent operation.



# WORK EASIER – SAFELY

**Innovative techniques  
for maximum safety and long  
service lives with high  
serviceability at the same time**

## InjectionSystem

Only rotary lobe pumps from Vogelsang offer a way of significantly extending the service life of the lobes in your rotary lobe pump, thanks to our patented InjectionSystem. Field trials prove that it can extend pump lifetime by as much as 2.5 times.

The principle is ingeniously simple. It prevents damage to the lobe tips by disruptive matter, as the innovative geometry of the housing facilitates problem-free flow through the pump. The internal sealing of the pump is also improved. That increases not only its efficiency, but also its suction capacity.

### We offer you the following equipment variants

- Injection S offers symmetrical protection for clockwise and counterclockwise rotation.
- Injection A offers asymmetrical protection for clockwise or counterclockwise rotation.

### The advantages at a glance

- Significantly improved foreign matter resistance
- Increased efficiency and improved suction capacity – through optimized volumetric efficiency
- Significantly extended service life – up to 2.5 times longer in field trials

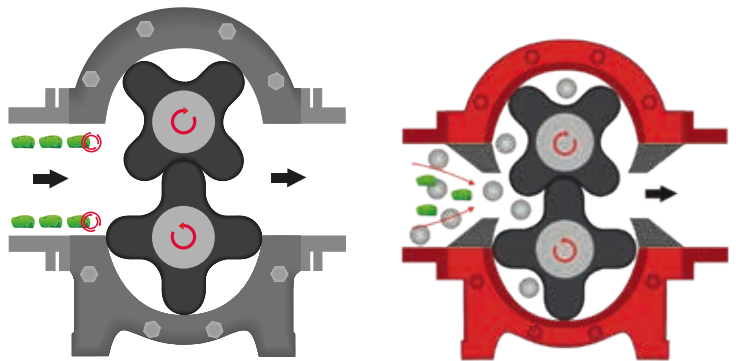

**Rotary lobe pump  
in conventional design**

**Rotary lobe pump  
with InjectionSystem**

## Quality Cartridge mechanical seal

### Professional sealing technology for maximum reliability

A pump seal that can be replaced in just one single step, significantly simplifying maintenance while also lowering the risk of transmission damage? This is a reality with the Quality Cartridge mechanical seal from Vogelsang. This mechanical seal in a cartridge design is completely preassembled. It represents the highest factory-tested safety standard, runs with minimal problems and installs quickly. Thanks to its unique construction, it incorporates all seal components, thus allowing reliable replacement of all the sealing elements when the gasket is changed – including the gasket between the gearbox and the buffer chamber. The Quality Cartridge mechanical seal is also highly user-friendly. It is preassembled for quick-and-easy replacement on-site, without the need for any expensive special tools.

### The advantages at a glance:

- Quick-and-easy change of seal: installation errors are prevented
- Installation takes less time than when changing conventional seals



### Cartridge mechanical seal repair

We offer optional repair of the Quality Cartridge mechanical seal. Use our complete spare parts kit and the installation tool to repair the mechanical seal yourself in a very short time. With this variant, you can keep your repair costs down.

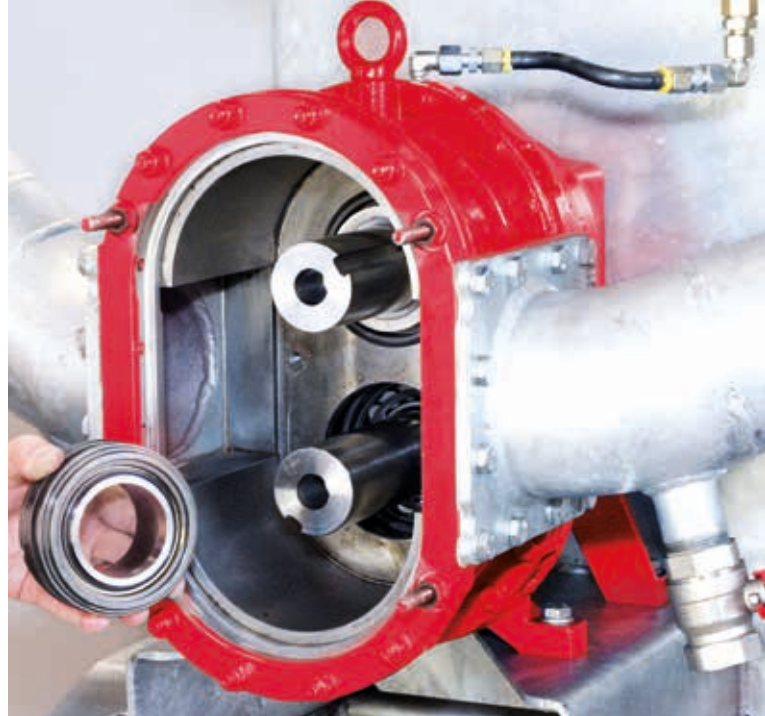

Quality Cartridge mechanical seal



Rotary lobe pump with InjectionSystem



## Optional extra for the VX series

### Pumps with manual gearbox

Vogelsang rotary lobe pumps with a connected three-speed gearbox make it possible to achieve different delivery rates almost independently of the motor speed. The gearbox also enables you to quickly fill the tank when idling and to optimally set the spreading capacity to the desired level during travel. The pump's gears can be shifted conveniently from the tractor cabin.

### A pump for three different drive types

The Vogelsang Universal Drive System (UDS) allows the same Vogelsang VX rotary lobe pump to be operated with a number of different types of drive. This is done by combining a pump from the VX series with a special shaft and drive adapter. This means it can be operated flexibly with a Cardan shaft, gearbox or hydraulic motor, depending on current requirements and the location of use.

### Monitored flow rate for precise spreading

By integrating a speed sensor, the flow rate can be precisely monitored during liquid manure spreading and the spreading quantity regulated as required on the basis of the speed measurements. Vogelsang offers this sensor in two variants:

**Variant A with UDS:** The speed sensor works in conjunction with the UDS. It is installed in the drive adapter and measures the speed on the adapter teeth.

**Variant B without UDS:** Screwed directly into the gearbox, the sensor measures the speed regardless of the drive type.



Speed sensor in conjunction with UDS



Speed sensor in gearbox



# FOCUSED ON PERFORMANCE

**Pumpen leicht gemacht  
mit der GL-Serie von Vogelsang**

**Up to 54% less weight**

For more load capacity  
on the vehicle

**Space savings of  
up to 35%**

28 cm shorter  
overall length

**Sophisticated wear  
plate geometry**

Seal service life up to  
4 times longer

**InjectionSystem**

Unique! The first integrated  
foreign matter protection for  
rotary lobe pumps, paired  
with higher self-sealing

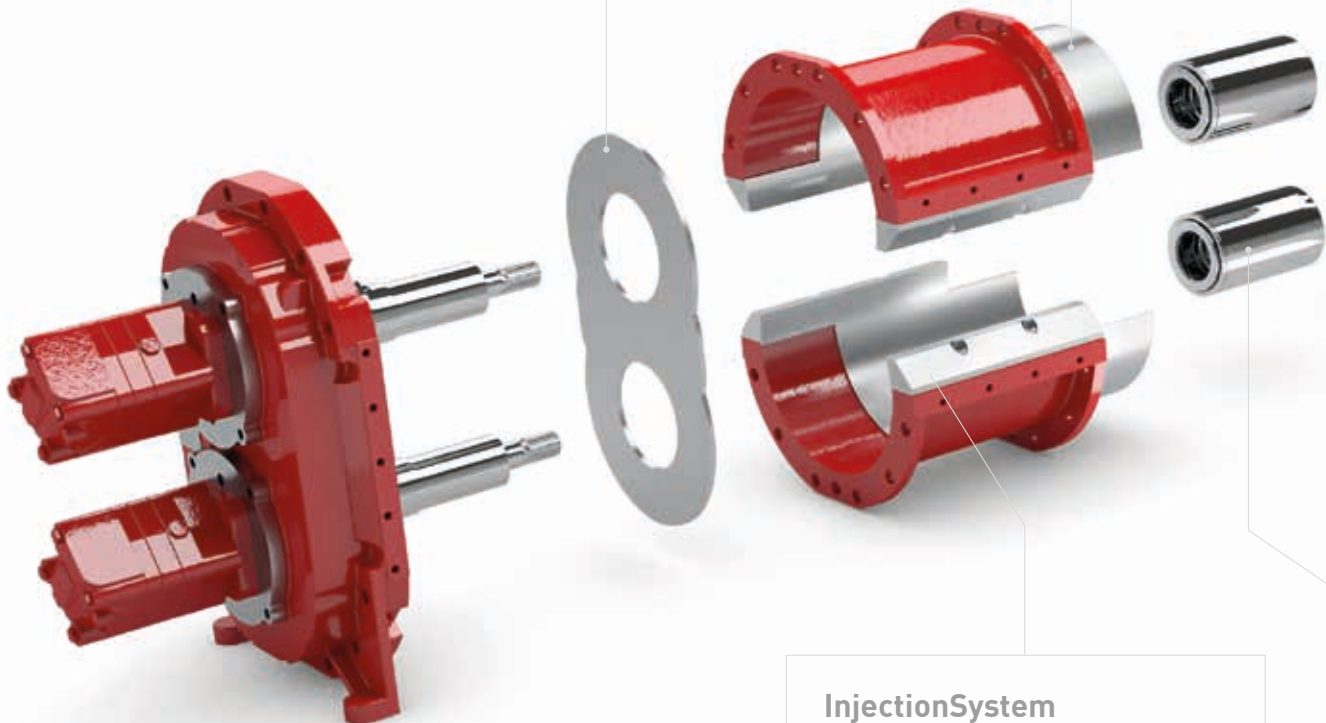



### Axial and radial wear plates

Lined pump housing made of highly wear-resistant special steel to extend service life and increase maintainability

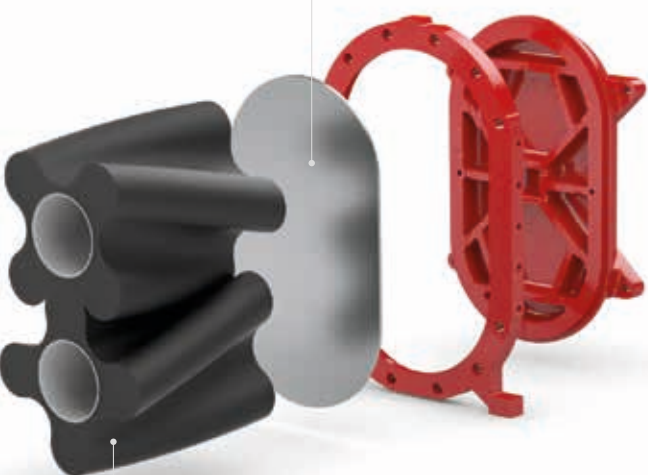

### HiFlo lobes

Pulsation-free pumping for very smooth running

### Quality Cartridge

Professional sealing technology for maximum reliability



### Even easier to service

The gearless design of the GL series also optimizes service work. For example, the lobes are lighter and can also be installed singularly, as no fitting keys are required.



### Advantages of the GL series

#### Weight saving of up to 54%

- Up to 151 kg weight saving compared to standard VX series models
- Up to 187 kg weight saving compared to similar models with hydraulic motors

#### Space saving of approx. 35%

- Up to 28 cm shorter overall length compared to standard VX series models
- Lower power consumption
- Even more service-friendly
- Unmatched smooth running

# PERFECT ADDITION TO THE PUMP PORTFOLIO

The ProCap T progressive  
cavity pump for tankers



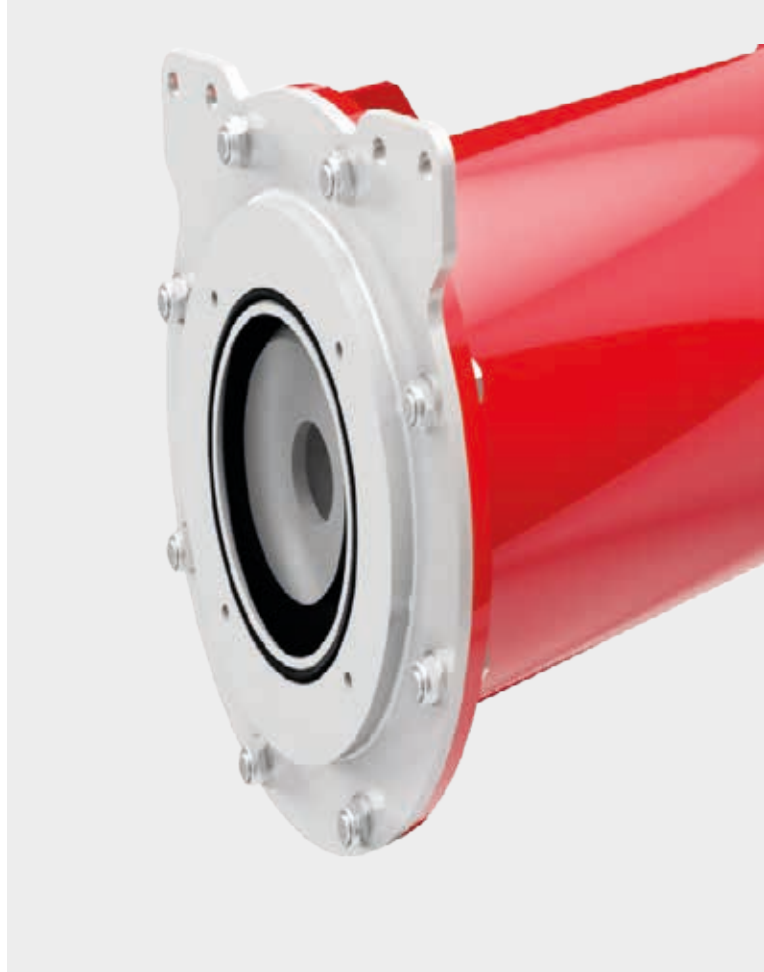

With the ProCap T progressive cavity pump, farmers who prefer this type of pump for spreading liquid manure can finally benefit from the reliability of Vogelsang products.

The compact pump is based on the same intelligent modular system as the larger floor-standing units – with complete or individual replacement of the stators and rotors. In addition to the robust internal workings, the fully welded housing ensures longer tool life and longer service life.

#### Equipment and options:

- High-quality mechanical seal for long pump service life
- Hollow rotor for smooth running
- Robust, maintenance-free universal joints
- Double bearings in the drive adapter for greater stability
- Optional: Reduction gear with low shaft misalignment

## SPECIFICATIONS

Series / type	ProCap T4250	ProCap T6000
<b>Displacement</b>	7.87 l/min	11.11 l/min
<b>Maximum delivery rate</b>	4,250 l	6,000 l
<b>Max. pressure</b>	6 bar	6 bar
<b>Max. speed</b>	540 rpm	540 rpm
<b>Inlet connection sizes</b>	3 x DN 200, square	3 x DN 200, square
<b>Outlet connection sizes</b>	1 x DN 200, square	1 x DN 200, square

#### Advantages of the ProCap T

- More compact installation dimensions compared to previous progressive cavity pumps
- Intelligent modular system for low spare parts inventory and greater flexibility
- Fully welded housing and large free passage for maximum durability
- Low-wear pumping thanks to high resistance to foreign bodies



# SHREDDING TECHNOLOGY WITH FOREIGN MATTER PROTECTION

## The powerful RotaCut® for cost-effective liquid manure treatment

The more flowable and homogeneous the liquid manure and digestates are, the more effectively they can be used as organic fertilizers. The RotaCut by Vogelsang shreds all the coarse and fibrous matter in the liquid manure. In addition, it provides effective protection against foreign matter and heavy material. On a liquid manure transport vehicle, RotaCut provides reliable protection for the pump system and ensures a homogeneous and easily metered liquid manure suspension.

### The principle

The continuously flowing medium passes first through the separator and is then fed to the cutter. Foreign objects (stones, metal parts, etc.) are separated out based on their size or weight and can be easily disposed of later via a cleaning port. Floating and suspended substances within the medium (fibers, hair, bones, wood, etc.) are transported to the cutting screen by the liquid current and shredded by rotating, self-sharpening cutting blades.

### The RotaCut principle of operation



### Advantages of the RotaCut®

- Efficient cutting performance
- High separation effect
- Simple maintenance and repair
- Wide range of series up to 12,000 l/min. throughput
- ACC for automatic adjustment of the cutting blades

### Functions

- Separating out foreign matter
- Cutting
- Homogenization

### Constant performance, long service life

Automatic Cut Control (ACC) by Vogelsang automatically adjusts the cutting blades in the RotaCut. This keeps the necessary contact pressure between the cutting blade and the cutting screen constant at all times, and the cutting performances at a constant high level. Manual maintenance is no longer necessary. The contact pressure can also be externally adapted to suit the medium during operation. For more information on ACC, see page 32.

### Especially for vehicles: Vogelsang RotaCut® MXL

The RotaCut MXL is the ideal solution for special requirements in the field of vehicle construction. It cuts fibers just as reliably as it separates heavy material, and can be easily installed on a vehicle. Its large opening provides easy access for service and maintenance, and heavy material is easy to remove.

### Higher yields for biogas plant operators

If substrates reach the digester well macerated and mashed, the gas yield increases significantly and the strain on the mixer is greatly reduced. Vogelsang offers energy-producing farmers a complete range of special RotaCut models for shredding, including the corresponding feeding systems.

For more, see our BIOGAS brochures or contact us directly. We would be happy to show you how you can optimize the substrate feeding process with a RotaCut.

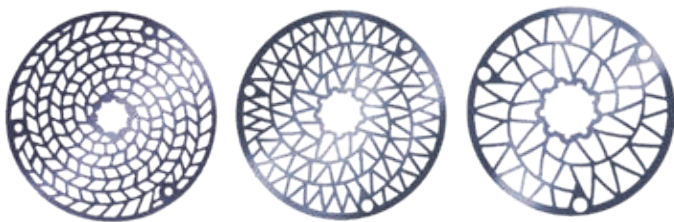

Vogelsang uses its proprietary software to calculate the optimized geometry for every size-reduction ratio. For you this means: the best geometry at all times for smooth running, with minimal wear. The cutting screens are produced from wear-resistant special steel and are reversible.

## SPECIFICATIONS

Type		RCQ-20	RC3000	RC5000	RC10000	RCX-48	RCX - 58
<b>Maximum flow rate</b>	m <sup>3</sup> /h	90	180	300	600	600	750
<b>Geared motor</b>	min <sup>-1</sup>	87 - 320	76 - 326	66 - 330	66 - 319	114 - 311	94 - 276
Optional speed	kW	1.1 - 2.2	1.5 - 4	1.5 - 7.5	2.2 - 7.5	5.5 - 11	7.5 - 15
Optional motor output							
<b>Hydraulic motor</b>	bar		50 - 70	60 - 80	70 - 100		180 - 230
Required oil pressure	l/m		40	45	60		75
<b>Model type overview</b>		Inline	Inline	Inline	Inline	-	-
		-	-	-	-	RCX	RCX
		-	MXL	MXL	MXL	-	-
		-	-	M/MX	-	-	MXL
		-	-	Compact XL	Compact XL	-	-
<b>Cutting screen with available free passage</b>	mm	10/ 15/ 20	8 / 10 / 12 15 / 20 / 28	4 / 8 / 10 / 12 15 / 24 / 30	4 / 8 / 10 / 12 / 16 20 / 25 / 34 / 38	4 / 8 / 10 / 12 / 16 20 / 25 / 34 / 38	8 / 12 / 16 25 / 34



ACC cross-section

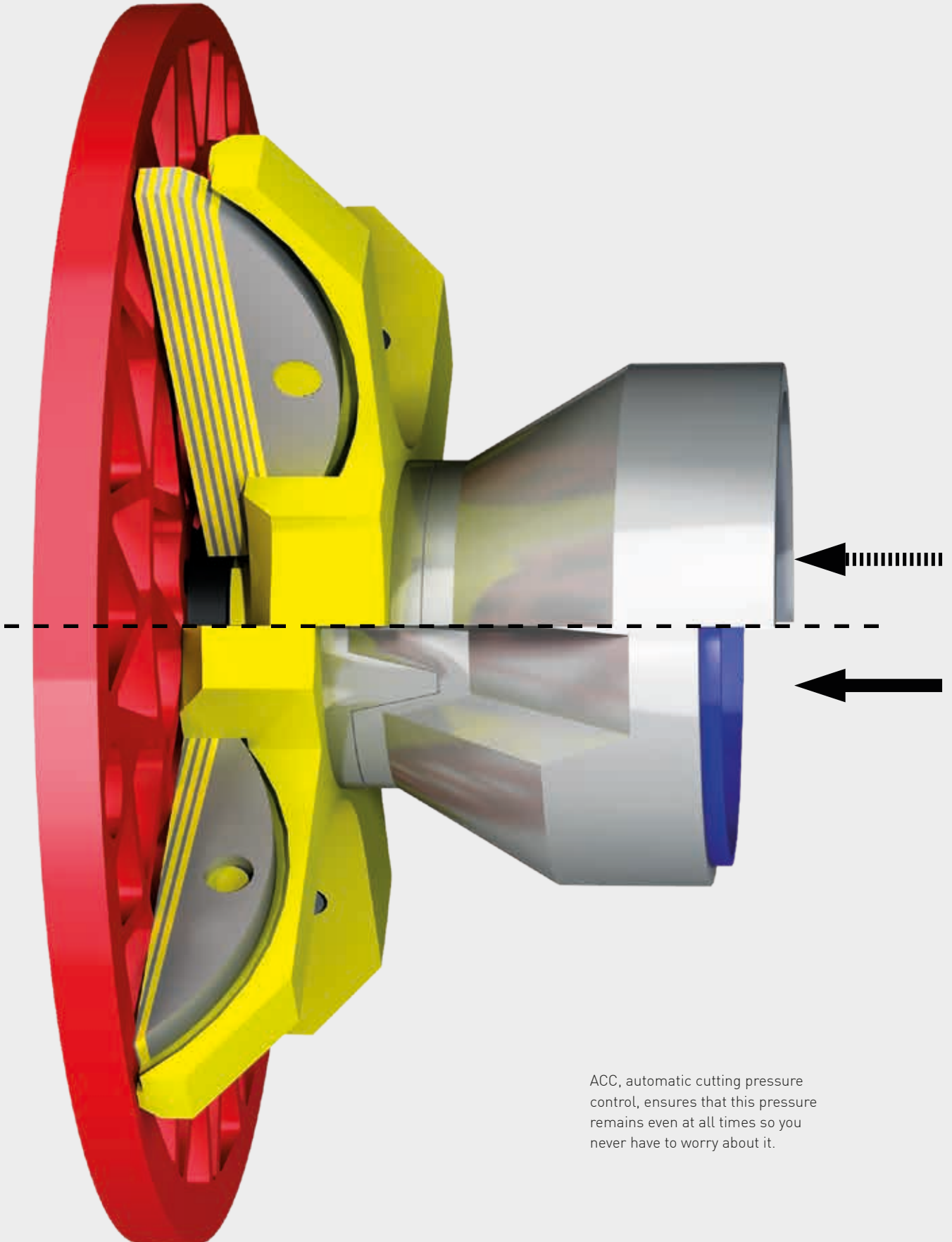

ACC, automatic cutting pressure control, ensures that this pressure remains even at all times so you never have to worry about it.



# BASIS FOR EFFICIENT SHREDDING

**ACC, the automatic cutting pressure control, constantly ensures optimal contact pressure**

## **ACC – Automatic Cut Control**

The RotaCut is a macerator that uses direct contact between the cutting blades and the cutting screen. It reliably macerates long-fibered materials such as straw or hay in media.

## **The automatic control unit reduces wear and tear**

ACC adjusts the contact pressure between the cutting blades and cutting screen to a level as high as is necessary and as low as is possible. This considerably prolongs the service life of the cutting blades in an automated fashion, as opposed to a manual blade adjustment. As a result, ACC is a reliable basis for increased efficiency and ensures consistent cutting performance for the life cycle of the wear parts.

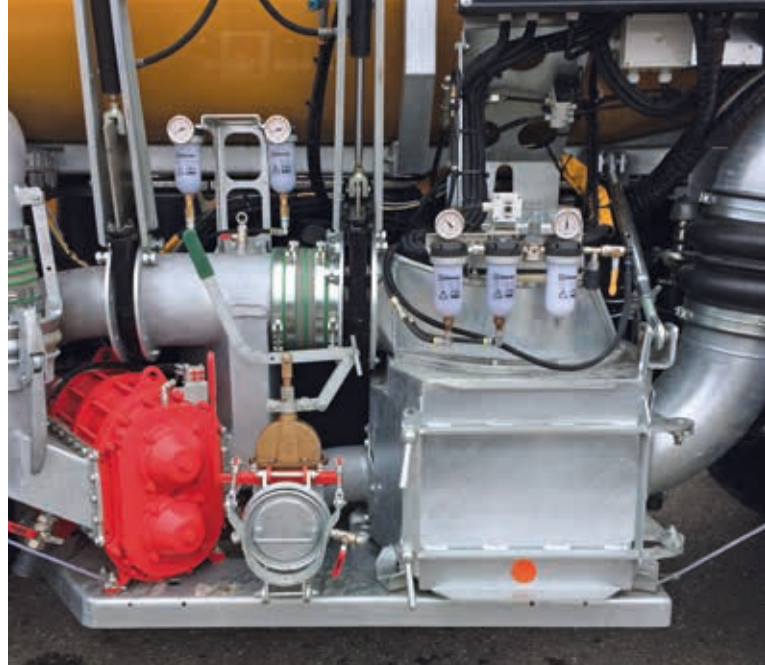

## **Advantages of the ACC**

- No manual cutting blade adjustment required; fully automatic, uninterrupted operation
- Contact pressure can be readily adjusted to the medium without interrupting operation
- Low operating costs thanks to minimum wear and low current consumption
- Optimal results due to consistently high cutting performance and constant size-reduction ratio

# FAST FILLING MADE EASY

Complete filling of vacuum tanks  
with the PowerFill

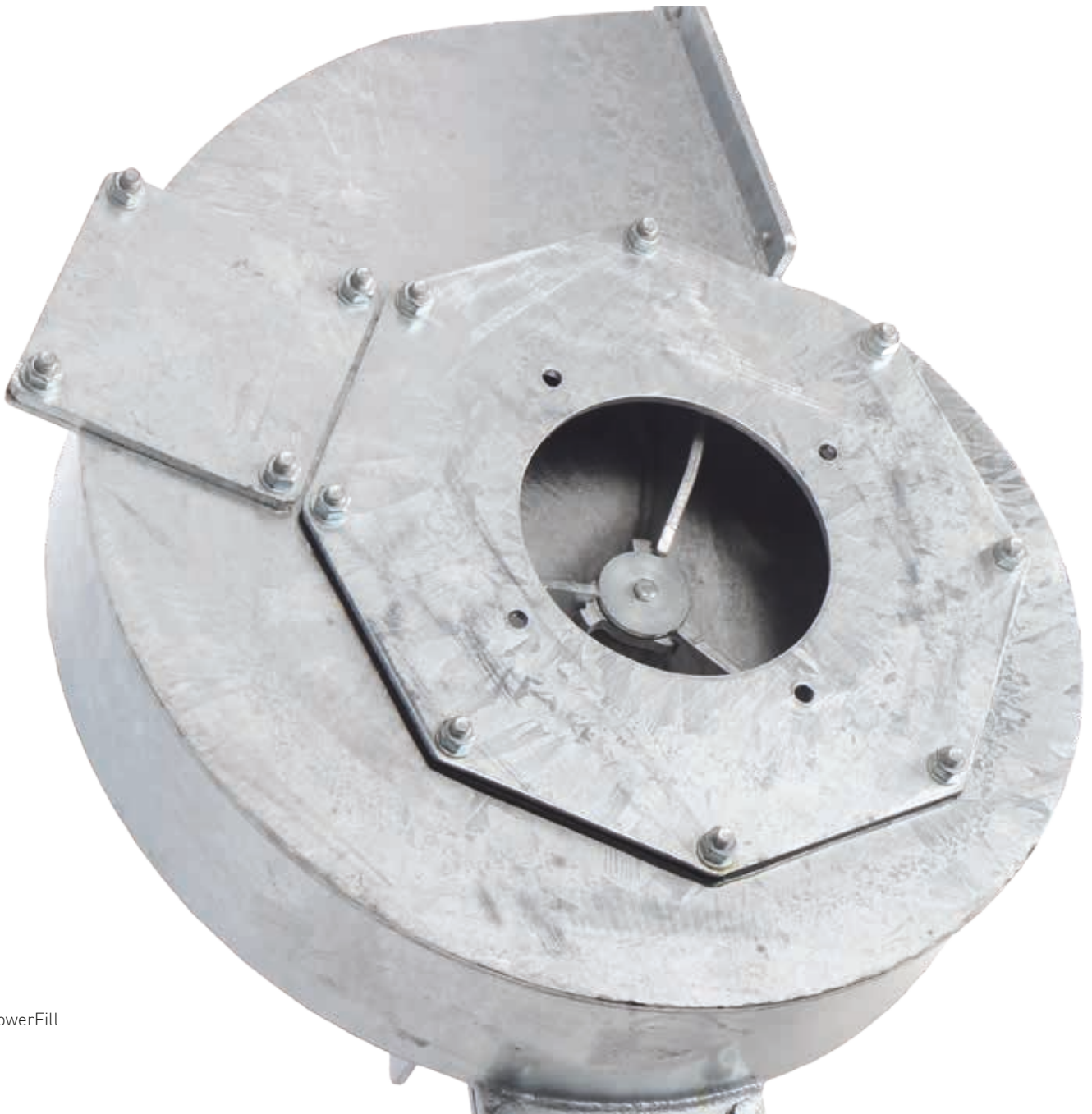



### Simple and efficient

The tanker is filled quickly. Thanks to the PowerFill, the full utilization of the transport volume is ensured by complete filling.

Vacuum tanks can be filled up to 30 % faster using a PowerFill-series turbo filler from Vogelsang – and with significantly less foam formation than with conventional fillers. This enables farmers to fully fill their tankers quickly and efficiently, resulting in decisive time-savings. This is thanks to the comparatively low speed of the PowerFill pumps. At the same time, the pumping process ensures homogenization of the liquid manure before distribution, leading to even more spreading.

The PowerFill is available in three different performance categories. With the PowerFill Small the Vogelsang developers have succeeded in incorporating all of these advantageous characteristics into a turbo filler with 40 % less weight and extremely compact dimensions. The PowerFill Small is available with two different drive variants. Both are designed to be flow-optimized for higher volume flow. The more powerful drive achieves a volume flow of up to 12,000 l/min.

### Advantages of the PowerFill

- Up to 30% less filling time for tankers with vacuum system
- Complete utilization of the transport volume thanks to complete filling and less foam formation
- More precise liquid manure spreading due to homogenization
- Easy to retrofit
- Surprising performance despite an even more compact design
- High volume flow thanks to optimized engineering



PowerFill Small for complete filling

## SPECIFICATIONS

Type designation	PowerFill			PowerFill S (Small)	
	PowerFill with OMR 100	PowerFill with OMS 100	PowerFill with SCM 084	PowerFill S with OMS 100	PowerFill S with SCM 084
<b>Motor type: Hydraulic motor</b>	OMR 100	OMS 100	SCM 084	OMS 100	SCM 084
<b>Speed</b>	600 rpm	750 rpm	1,000 rpm	750 rpm	1,000 rpm
<b>Operating pressure</b>	140 - 160 bar	140 - 160 bar	200 - 350 bar	140 - 160 bar	200 - 350 bar
<b>Hydraulic capacity of tractor</b>	Min. 55 l/min	Min. 65 l/min	Min. 65 l/min	Min. 65 l/min	Min. 65 l/min
<b>Max. quantity delivered</b>	70 l/min	85 l/min	90 l/min	85 l/min	90 l/min
<b>Optimal quantity delivered</b>	60 l/min	75 l/min	85 l/min	75 l/min	85 l/min
<b>Connector flanges</b>	6", DN 150	8", DN 200	8", DN 200	8", DN 200	8", DN 200



FillMaster M

# FILLING RAPIDLY AND SAFELY

**FillMaster – Powerful filling stations for convenient and quick filling of tankers everywhere**

## **FillMaster S**

The stationary FillMaster S enables convenient and quick filling of tankers from containers or digesters. There is no need for the complex, time-consuming coupling and uncoupling of hoses. The filling connector with double telescope can be lowered manually or electrically (optional). In this way, any tank can be filled quickly via the dome. FillMaster S can be equipped with a convenient wireless remote control or a wired remote control on request. Depending on the application, capacities of up to 11,000 l/ min can be achieved. It can be equipped with a rotary lobe pump from the VX series or a PowerFill. Various drive concepts are available.

## **Further developed: FillMaster M**

The mobile FillMaster M with three-point fixture can be transported by a tractor. Its centerpiece is a rotary lobe pump from the VX series, driven by the cardan shaft.

**The FillMaster M is available in three basic versions with either a 6,000 or 9,000 l/min pump:**

- VX rotary lobe pump with RotaCut cutter
- VX rotary lobe pump with riser pipe with boom
- VX rotary lobe pump with RotaCut cutter and riser pipe with boom

Analog pressure monitoring and the integration of the RotaCut MXL with Automatic Cut Control (ACC) are optional.

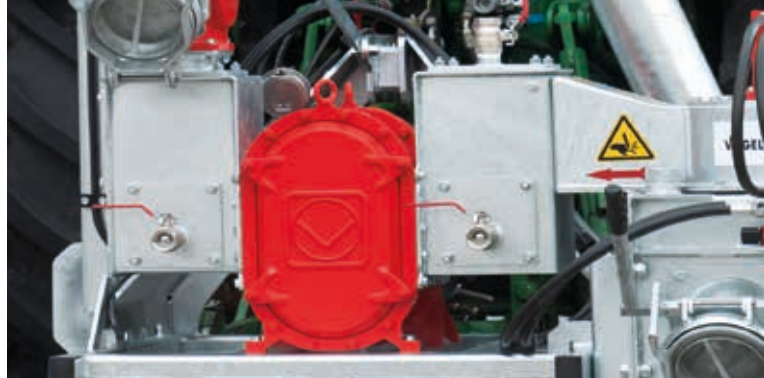

## **Vogelsang VX pumps for the FillMaster**

The VX186-260Q and -368Q rotary lobe pumps from the VX series are permissible for the FillMaster S and M.

*For specifications on the capacity, see page 18.*

## **Advantages of the FillMaster M**

- Very user-friendly tank filling station
- Customized solution for each application
- High maintainability
- Easy retrofitting of further options possible (e. g. riser pipe with boom)

# WHEN IT COMES TO SERVICE, WE LEAVE NOTHING TO CHANCE

**Comprehensive services  
for smooth operation and  
a long lifetime**

## **Support and supply from A to Z**

Because we are aware that close customer proximity is essential for our mutual success, we design our services to best meet your needs. In Germany and in countries where we have subsidiaries, Vogelsang service centers and contractual partners generate an active dialog with our customers and provide reliable support.

This means you always get the precise support you need in every phase of our partnership. Our highly qualified staff make it possible – experts such as consultants and technicians who know your Vogelsang machines inside and out.



Since its establishment in 1929, Vogelsang has become an internationally recognized mechanical engineering company with numerous branches, sales centers and subsidiaries.



### **We think ahead**

Thinking ahead in your best interest begins with our extensive and detailed product documentation. Spare parts are available within a short time due to our high degree of vertical integration in production. In addition, you will always find an authorized service partner in your area who can help with repairs and wear part replacement. The Vogelsang ServicePack completes the offer. Whether you need start-up, on-site training, training at the Vogelsang facility, or full service support with a maintenance contract and a wear parts service package – we offer a support program tailored specifically to your needs.

## What we offer

We provide solutions in the following sectors:  
AGRICULTURAL TECHNOLOGY, BIOGAS,  
INDUSTRY, TRANSPORTATION, WASTEWATER



## Our broad range of products and services

- Consulting and service
- Data management and control technology
- Disintegration technology
- Individually tailored solutions for special applications
- Pumps and pump systems
- Solid matter feeders
- Solids reduction, separators and mixers
- Spreading technology
- Supply, disposal and cleaning

Copyright 2022 Vogelsang GmbH & Co. KG

Product availability, appearance, technical specifications and details are subject to continuous development. All information presented here is therefore subject to change. In selected countries, Vogelsang®, BioCrack®, BioCut®, BlackBird®, CC-Serie®, EnergyJet®, PreMix®, RotaCut®, XRipper®, XSplit® and XTill® are registered trademarks of Vogelsang GmbH & Co. KG, Essen (Oldenburg), Germany.

All rights reserved, including the rights to all graphics and images.

Powerful and reliable agricultural technology\_EN\_09207722\_500\_MET1112 – Printed in Germany

Vogelsang GmbH & Co. KG  
Holthoeye 10 – 14 | 49632 Essen (Oldenburg) | Germany  
Phone: +49 5434 83 - 0 | Fax: +49 5434 83 -10  
germany@vogelsang.info

[vogelsang.info](http://vogelsang.info)